



Range of roof mounted axial flow fans, with vertical air discharge configuration, for air extract.

Designed for smoke extraction in fire conditions and certified F400-120 and F300-120 (HGHT-V - CE marked). Casing formed from rolled sheet steel welded on the base with a corrosion resistant hot dipped galvanized finish. High grade die-cast aluminum blades locked within a pressed sheet steel hub. Backdraft shutter and proof guard at the fan discharge. Cylindrical casing formed from rolled sheet steel protected against corrosion by grey polyester paint coating.

**Motors**

- HGHT-V F400-120: three-phase 4 pole motors 400V-50Hz, IP55, class H insulation.
- HGHT-V: F300-120: three-phase 4 pole motors 400V-50Hz, IP55, class H insulation.
- Electrical isolator fitted to fan casing. Three phase 230/400V-50Hz up to 3 kW. Three phase 400V-50Hz, for higher power motors and two speed motors. (See characteristics chart). Motors suitable for inverter control. In emergency operation, no need for DOL or de-rating, as long as the VFTM range of VSDs is used, and/or requirements defined in EN 12101-3 are followed.

**Additional Information**

Standard air direction: form (A) configuration (Motor over impeller).

**On request**

- 6 pole motors.
- 2 speed motors 4/6 and 4/8 poles.

**Specific applications**



Officially approved to EN12101-3 standard. Certificate n° 0370-CPD-0909



Officially approved to EN12101-3 standard. Certificate n° 0370-CPD-0923



Car parks

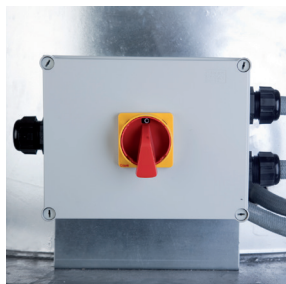

**Isolator**  
Electrical isolator.



**Outlet guard**  
Outlet guard protection.

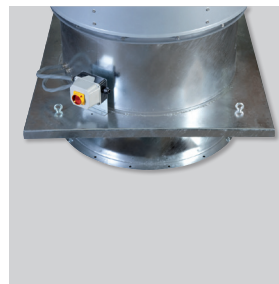

**Support base**  
Base for roof installation.



**Inlet flange**  
Flange for duct connection or bellmouth inlet.

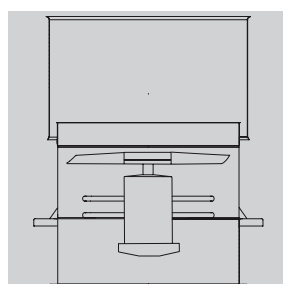

**Form (A) configuration**  
Standard air direction: form (A) configuration (Motor over impeller).

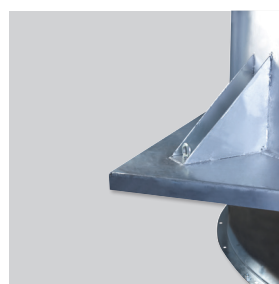

**Web support**  
To strengthen base support. Model 1250 only.



**Back draft shutter**  
Prevent back draft of air and entrance of rain water when the fan is switched off.

### TECHNICAL CHARACTERISTICS

Before installation check that the product electrical characteristics listed on the data plate label (voltage, power, frequency, etc.) match those of the intended electrical supply.

#### TECHNICAL CHARACTERISTICS - F400 - 4 POLES

Model	Diameter (mm)	Motor power	Full load current at 400V (A)	Weight (kg)
HGHT-V/4-800-6/-1,5	800	1,5	3,17	170
HGHT-V/4-800-6/-2,2	800	2,2	4,56	179
HGHT-V/4-800-6/-3	800	3	6,15	185
HGHT-V/4-800-6/-4	800	4	8,03	191
HGHT-V/4-800-6/-5,5	800	5,5	10,4	213
HGHT-V/4-800-6/-7,5	800	7,5	13,9	221

HGHT-V/4-800-9/-2,2	800	2,2	4,56	184
HGHT-V/4-800-9/-3	800	3	6,15	190
HGHT-V/4-800-9/-4	800	4	8,03	196
HGHT-V/4-800-9/-5,5	800	5,5	10,4	218
HGHT-V/4-800-9/-7,5	800	7,5	13,9	226

HGHT-V/4-900-6/-11	900	11	20,9	302
HGHT-V/4-900-6/-3	900	3	6,15	227
HGHT-V/4-900-6/-4	900	4	8,03	233
HGHT-V/4-900-6/-5,5	900	5,5	10,4	255
HGHT-V/4-900-6/-7,5	900	7,5	13,9	263

HGHT-V/4-900-9/-11	900	11	20,9	308
HGHT-V/4-900-9/-15	900	15	27,9	330
HGHT-V/4-900-9/-5,5	900	5,5	10,4	261
HGHT-V/4-900-9/-7,5	900	7,5	13,9	269

Model	Diameter (mm)	Motor power	Full load current at 400V (A)	Weight (kg)
HGHT-V/4-1000-6/-11	1000	11	20,9	317
HGHT-V/4-1000-6/-15	1000	15	27,9	339
HGHT-V/4-1000-6/-18,5	1000	18,5	35,1	372
HGHT-V/4-1000-6/-4	1000	4	8,03	248
HGHT-V/4-1000-6/-5,5	1000	5,5	10,4	270
HGHT-V/4-1000-6/-7,5	1000	7,5	13,9	278

HGHT-V/4-1000-9/-11	1000	11	20,9	324
HGHT-V/4-1000-9/-15	1000	15	27,9	346
HGHT-V/4-1000-9/-18,5	1000	18,5	35,1	379
HGHT-V/4-1000-9/-22	1000	22	41	396
HGHT-V/4-1000-9/-7,5	1000	7,5	13,9	285

HGHT-V/4-1250-6/-15	1250	15	27,9	463
HGHT-V/4-1250-6/-18,5	1250	18,5	35,1	496
HGHT-V/4-1250-6/-22	1250	22	41	513
HGHT-V/4-1250-6/-30	1250	30	57,1	556
HGHT-V/4-1250-6/-37	1250	37	66,8	693
HGHT-V/4-1250-6/-45	1250	45	80,9	728

HGHT-V/4-1250-9/-15	1250	15	27,9	473
HGHT-V/4-1250-9/-18,5	1250	18,5	35,1	506
HGHT-V/4-1250-9/-22	1250	22	41	523
HGHT-V/4-1250-9/-30	1250	30	57,1	566
HGHT-V/4-1250-9/-37	1250	37	66,8	703
HGHT-V/4-1250-9/-45	1250	45	80,9	738

#### TECHNICAL CHARACTERISTICS - F400 120 - 4/8 POLES

Model	Diameter (mm)	Motor power		Full load current 400V (A)		Weight (kg)
		HS	LS	HS	LS	

HGHT-V/4/8-800-6/-1,5/0,25	800	1,5	0,25	3,65	1,6	177
HGHT-V/4/8-800-6/-2,2/0,37	800	2,2	0,37	4,7	1,66	185
HGHT-V/4/8-800-6/-3/0,55	800	3	0,55	6,29	2,35	186
HGHT-V/4/8-800-6/-4/0,75	800	4	0,75	8,44	2,25	193
HGHT-V/4/8-800-6/-5,5/1,1	800	5,5	1,1	11,7	3,7	215
HGHT-V/4/8-800-6/-7,5/1,5	800	7,5	1,5	15,9	4,72	228

HGHT-V/4/8-800-9/-2,2/0,37	800	2,2	0,37	4,7	1,66	190
HGHT-V/4/8-800-9/-3/0,55	800	3	0,55	6,29	2,35	191
HGHT-V/4/8-800-9/-4/0,75	800	4	0,75	8,44	2,25	198
HGHT-V/4/8-800-9/-5,5/1,1	800	5,5	1,1	11,7	3,7	220
HGHT-V/4/8-800-9/-7,5/1,5	800	7,5	1,5	15,9	4,72	233

Model	Diameter (mm)	Motor power		Full load current 400V (A)		Weight (kg)
		HS	LS	HS	LS	

HGHT-V/4/8-900-6/-11/3	900	11	3	21	7	301
HGHT-V/4/8-900-6/-2,2/0,37	900	2,2	0,37	4,7	1,66	227
HGHT-V/4/8-900-6/-3/0,55	900	3	0,55	6,29	2,35	228
HGHT-V/4/8-900-6/-4/0,75	900	4	0,75	8,44	2,25	235
HGHT-V/4/8-900-6/-5,5/1,1	900	5,5	1,1	11,7	3,7	257
HGHT-V/4/8-900-6/-7,5/1,5	900	7,5	1,5	15,9	4,72	270

HGHT-V/4/8-900-9/-11/3	900	11	3	21	7	307
HGHT-V/4/8-900-9/-14/3,5	900	14	3,5	26,5	8,45	326
HGHT-V/4/8-900-9/-4/0,75	900	4	0,75	8,44	2,25	241
HGHT-V/4/8-900-9/-5,5/1,1	900	5,5	1,1	11,7	3,7	263
HGHT-V/4/8-900-9/-7,5/1,5	900	7,5	1,5	15,9	4,72	276

TECHNICAL CHARACTERISTICS - F400 120 - 4/8 POLES (CONTINUATION)

Model	Diameter (mm)	Motor power		Full load current 400V (A)		Weight (kg)
		HS	LS	HS	LS	
HGHT-V/4/8-1000-6/-11/3	1000	11	3	21	7	316
HGHT-V/4/8-1000-6/-14/3,5	1000	14	3,5	26,5	8,45	335
HGHT-V/4/8-1000-6/-17/4,3	1000	17	4,3	33,4	12,7	366
HGHT-V/4/8-1000-6/-20/5	1000	20	5	38,6	14,1	381
HGHT-V/4/8-1000-6/-4/0,75	1000	4	0,75	8,44	2,25	250
HGHT-V/4/8-1000-6/-5,5/1,1	1000	5,5	1,1	11,7	3,7	272
HGHT-V/4/8-1000-6/-7,5/1,5	1000	7,5	1,5	15,9	4,72	285
HGHT-V/4/8-1000-9/-11/3	1000	11	3	21	7	323
HGHT-V/4/8-1000-9/-14/3,5	1000	14	3,5	26,5	8,45	342
HGHT-V/4/8-1000-9/-17/4,3	1000	17	4,3	33,4	12,7	373
HGHT-V/4/8-1000-9/-20/5	1000	20	5	38,6	14,1	388
HGHT-V/4/8-1000-9/-5,5/1,1	1000	5,5	1,1	11,7	3,7	279
HGHT-V/4/8-1000-9/-7,5/1,5	1000	7,5	1,5	15,9	4,72	292

Model	Diameter (mm)	Motor power		Full load current 400V (A)		Weight (kg)
		HS	LS	HS	LS	
HGHT-V/4/8-1250-6/-11/3	1250	11	3	21	7	440
HGHT-V/4/8-1250-6/-14/3,5	1250	14	3,5	26,5	8,45	459
HGHT-V/4/8-1250-6/-17/4,3	1250	17	4,3	33,4	12,7	490
HGHT-V/4/8-1250-6/-20/5	1250	20	5	38,6	14,1	505
HGHT-V/4/8-1250-6/-28/6,5	1250	28	6,5	52	18	563
HGHT-V/4/8-1250-6/-30/8	1250	30	8	56,5	21,8	593
HGHT-V/4/8-1250-6/-37/9,2	1250	37	9,2	74,2	25,4	696
HGHT-V/4/8-1250-6/-44/11	1250	44	11	80,2	27,2	753
HGHT-V/4/8-1250-9/-14/3,5	1250	14	3,5	26,5	8,45	469
HGHT-V/4/8-1250-9/-17/4,3	1250	17	4,3	33,4	12,7	500
HGHT-V/4/8-1250-9/-20/5	1250	20	5	38,6	14,1	515
HGHT-V/4/8-1250-9/-28/6,5	1250	28	6,5	52	18	573
HGHT-V/4/8-1250-9/-30/8	1250	30	8	56,5	21,8	603
HGHT-V/4/8-1250-9/-37/9,2	1250	37	9,2	74,2	25,4	706
HGHT-V/4/8-1250-9/-44/11	1250	44	11	80,2	27,2	763

TECHNICAL CHARACTERISTICS - F400 120 - 4/6 POLES

Model	Diameter (mm)	Motor power		Full load current 400V (A)		Weight (kg)
		HS	LS	HS	LS	
HGHT-V/4/6-800-6/-1,5/0,37	800	1,5	0,37	3,65	1,62	167
HGHT-V/4/6-800-6/-2,2/0,7	800	2,2	0,7	4,91	2,48	174
HGHT-V/4/6-800-6/-3/1	800	3	1	6,85	3,86	183
HGHT-V/4/6-800-6/-4,5/1,5	800	4,5	1,5	10,2	5,38	215
HGHT-V/4/6-800-6/-6/2,2	800	6	2,2	13,7	6,96	226
HGHT-V/4/6-800-9/-2,2/0,7	800	2,2	0,7	4,91	2,48	179
HGHT-V/4/6-800-9/-3/1	800	3	1	6,85	3,86	188
HGHT-V/4/6-800-9/-4,5/1,5	800	4,5	1,5	10,2	5,38	220
HGHT-V/4/6-800-9/-6/2,2	800	6	2,2	13,7	6,96	231
HGHT-V/4/6-900-6/-10/3,3	900	10	3,3	22	8,74	309
HGHT-V/4/6-900-6/-14/4,5	900	14	4,5	29,5	11,2	324
HGHT-V/4/6-900-6/-2,2/0,7	900	2,2	0,7	4,91	2,48	216
HGHT-V/4/6-900-6/-3/1	900	3	1	6,85	3,86	225
HGHT-V/4/6-900-6/-4,5/1,5	900	4,5	1,5	10,2	5,38	257
HGHT-V/4/6-900-6/-6/2,2	900	6	2,2	13,7	6,96	268
HGHT-V/4/6-900-9/-10/3,3	900	10	3,3	22	8,74	315
HGHT-V/4/6-900-9/-14/4,5	900	14	4,5	29,5	11,2	330
HGHT-V/4/6-900-9/-4,5/1,5	900	4,5	1,5	10,2	5,38	263
HGHT-V/4/6-900-9/-6/2,2	900	6	2,2	13,7	6,96	274

Model	Diameter (mm)	Motor power		Full load current 400V (A)		Weight (kg)
		HS	LS	HS	LS	
HGHT-V/4/6-1000-6/-10/3,3	1000	10	3,3	22	8,74	324
HGHT-V/4/6-1000-6/-14/4,5	1000	14	4,5	29,5	11,2	339
HGHT-V/4/6-1000-6/-16/6,5	1000	16	6,5	28,4	12,5	399
HGHT-V/4/6-1000-6/-20/8,5	1000	20	8,5	34,9	16,3	434
HGHT-V/4/6-1000-6/-4,5/1,5	1000	4,5	1,5	10,2	5,38	272
HGHT-V/4/6-1000-6/-6/2,2	1000	6	2,2	13,7	6,96	283
HGHT-V/4/6-1000-9/-10/3,3	1000	10	3,3	22	8,74	331
HGHT-V/4/6-1000-9/-14/4,5	1000	14	4,5	29,5	11,2	346
HGHT-V/4/6-1000-9/-16/6,5	1000	16	6,5	28,4	12,5	406
HGHT-V/4/6-1000-9/-20/8,5	1000	20	8,5	34,9	16,3	441
HGHT-V/4/6-1000-9/-6/2,2	1000	6	2,2	13,7	6,96	290
HGHT-V/4/6-1250-6/-10/3,3	1250	10	3,3	22	8,74	448
HGHT-V/4/6-1250-6/-14/4,5	1250	14	4,5	29,5	11,2	463
HGHT-V/4/6-1250-6/-16/6,5	1250	16	6,5	28,4	12,5	523
HGHT-V/4/6-1250-6/-20/8,5	1250	20	8,5	34,9	16,3	558
HGHT-V/4/6-1250-6/-26/9	1250	26	9	47,7	18,6	608
HGHT-V/4/6-1250-6/-34/12	1250	34	12	65,6	28	707
HGHT-V/4/6-1250-6/-40/14	1250	40	14	75,5	29	761

### TECHNICAL CHARACTERISTICS - F400 120 - 4/6 POLES (CONTINUATION)

Model	Diameter (mm)	Motor power		Full load current 400V (A)		Weight (kg)
		HS	LS	HS	LS	
HGHT-V/4/6-1250-9/-14/4,5	1250	14	4,5	29,5	11,2	473
HGHT-V/4/6-1250-9/-16/6,5	1250	16	6,5	28,4	12,5	533
HGHT-V/4/6-1250-9/-20/8,5	1250	20	8,5	34,9	16,3	568
HGHT-V/4/6-1250-9/-26/9	1250	26	9	47,7	18,6	618
HGHT-V/4/6-1250-9/-34/12	1250	34	12	65,6	28	717
HGHT-V/4/6-1250-9/-40/14	1250	40	14	75,5	29	771

### TECHNICAL CHARACTERISTICS - F300 - 4 POLES

Model	Diameter (mm)	Motor power	Full load current at 400V (A)	Weight (kg)
HGHT-V/4-800-6/-1,5	800	1,5	3,17	170
HGHT-V/4-800-6/-2,2	800	2,2	4,56	179
HGHT-V/4-800-6/-3	800	3	6,15	185
HGHT-V/4-800-6/-4	800	4	8,03	191
HGHT-V/4-800-6/-5,5	800	5,5	10,4	213
HGHT-V/4-800-6/-7,5	800	7,5	13,9	221
HGHT-V/4-800-9/-2,2	800	2,2	4,56	184
HGHT-V/4-800-9/-3	800	3	6,15	190
HGHT-V/4-800-9/-4	800	4	8,03	196
HGHT-V/4-800-9/-5,5	800	5,5	10,4	218
HGHT-V/4-800-9/-7,5	800	7,5	13,9	226
HGHT-V/4-900-6/-11	900	11	20,9	302
HGHT-V/4-900-6/-3	900	3	6,15	227
HGHT-V/4-900-6/-4	900	4	8,03	233
HGHT-V/4-900-6/-5,5	900	5,5	10,4	255
HGHT-V/4-900-6/-7,5	900	7,5	13,9	263
HGHT-V/4-900-9/-11	900	11	20,9	308
HGHT-V/4-900-9/-15	900	15	27,9	330
HGHT-V/4-900-9/-5,5	900	5,5	10,4	261
HGHT-V/4-900-9/-7,5	900	7,5	13,9	269
HGHT-V/4-1000-6/-11	1000	11	20,9	317
HGHT-V/4-1000-6/-15	1000	15	27,9	339
HGHT-V/4-1000-6/-18,5	1000	18,5	35,1	372
HGHT-V/4-1000-6/-4	1000	4	8,03	248
HGHT-V/4-1000-6/-5,5	1000	5,5	10,4	270
HGHT-V/4-1000-6/-7,5	1000	7,5	13,9	278

Model	Diameter (mm)	Motor power	Full load current at 400V (A)	Weight (kg)
HGHT-V/4-1000-9/-11	1000	11	20,9	324
HGHT-V/4-1000-9/-15	1000	15	27,9	346
HGHT-V/4-1000-9/-18,5	1000	18,5	35,1	379
HGHT-V/4-1000-9/-22	1000	22	41	396
HGHT-V/4-1000-9/-7,5	1000	7,5	13,9	285
HGHT-V/4-1250-6/-15	1250	15	27,9	463
HGHT-V/4-1250-6/-18,5	1250	18,5	35,1	496
HGHT-V/4-1250-6/-22	1250	22	41	513
HGHT-V/4-1250-6/-30	1250	30	57,1	556
HGHT-V/4-1250-6/-37	1250	37	66,8	693
HGHT-V/4-1250-9/-15	1250	15	27,9	473
HGHT-V/4-1250-9/-18,5	1250	18,5	35,1	506
HGHT-V/4-1250-9/-22	1250	22	41	523
HGHT-V/4-1250-9/-30	1250	30	57,1	566
HGHT-V/4-1250-9/-37	1250	37	66,8	703

### TECHNICAL CHARACTERISTICS - F300 120 - 4/8 POLES

Model	Diameter (mm)	Motor power		Full load current 400V (A)		Weight (kg)
		HS	LS	HS	LS	
HGHT-V/4/8-800-6/-1,5/0,25	800	1,5	0,25	3,65	1,6	177
HGHT-V/4/8-800-6/-2,2/0,37	800	2,2	0,37	4,7	1,66	185
HGHT-V/4/8-800-6/-3/0,55	800	3	0,55	6,29	2,35	186
HGHT-V/4/8-800-6/-4/0,75	800	4	0,75	8,44	2,25	193
HGHT-V/4/8-800-6/-5,5/1,1	800	5,5	1,1	11,7	3,7	215
HGHT-V/4/8-800-6/-7,5/1,5	800	7,5	1,5	15,9	4,72	228
HGHT-V/4/8-800-9/-2,2/0,37	800	2,2	0,37	4,7	1,66	190
HGHT-V/4/8-800-9/-3/0,55	800	3	0,55	6,29	2,35	191
HGHT-V/4/8-800-9/-4/0,75	800	4	0,75	8,44	2,25	198
HGHT-V/4/8-800-9/-5,5/1,1	800	5,5	1,1	11,7	3,7	220
HGHT-V/4/8-800-9/-7,5/1,5	800	7,5	1,5	15,9	4,72	233
HGHT-V/4/8-900-6/-11/3	900	11	3	21	7	301
HGHT-V/4/8-900-6/-2,2/0,37	900	2,2	0,37	4,7	1,66	227
HGHT-V/4/8-900-6/-3/0,55	900	3	0,55	6,29	2,35	228
HGHT-V/4/8-900-6/-4/0,75	900	4	0,75	8,44	2,25	235
HGHT-V/4/8-900-6/-5,5/1,1	900	5,5	1,1	11,7	3,7	257
HGHT-V/4/8-900-6/-7,5/1,5	900	7,5	1,5	15,9	4,72	270
HGHT-V/4/8-900-9/-11/3	900	11	3	21	7	307
HGHT-V/4/8-900-9/-14/3,5	900	14	3,5	26,5	8,45	326
HGHT-V/4/8-900-9/-4/0,75	900	4	0,75	8,44	2,25	241
HGHT-V/4/8-900-9/-5,5/1,1	900	5,5	1,1	11,7	3,7	263
HGHT-V/4/8-900-9/-7,5/1,5	900	7,5	1,5	15,9	4,72	276

Model	Diameter (mm)	Motor power		Full load current 400V (A)		Weight (kg)
		HS	LS	HS	LS	
HGHT-V/4/8-1000-6/-11/3	1000	11	3	21	7	316
HGHT-V/4/8-1000-6/-14/3,5	1000	14	3,5	26,5	8,45	335
HGHT-V/4/8-1000-6/-17/4,3	1000	17	4,3	33,4	12,7	366
HGHT-V/4/8-1000-6/-20/5	1000	20	5	38,6	14,1	381
HGHT-V/4/8-1000-6/-4/0,75	1000	4	0,75	8,44	2,25	250
HGHT-V/4/8-1000-6/-5,5/1,1	1000	5,5	1,1	11,7	3,7	272
HGHT-V/4/8-1000-6/-7,5/1,5	1000	7,5	1,5	15,9	4,72	285
HGHT-V/4/8-1000-9/-11/3	1000	11	3	21	7	323
HGHT-V/4/8-1000-9/-14/3,5	1000	14	3,5	26,5	8,45	342
HGHT-V/4/8-1000-9/-17/4,3	1000	17	4,3	33,4	12,7	373
HGHT-V/4/8-1000-9/-20/5	1000	20	5	38,6	14,1	388
HGHT-V/4/8-1000-9/-5,5/1,1	1000	5,5	1,1	11,7	3,7	279
HGHT-V/4/8-1000-9/-7,5/1,5	1000	7,5	1,5	15,9	4,72	292
HGHT-V/4/8-1250-6/-11/3	1250	11	3	21	7	440
HGHT-V/4/8-1250-6/-14/3,5	1250	14	3,5	26,5	8,45	459
HGHT-V/4/8-1250-6/-17/4,3	1250	17	4,3	33,4	12,7	490
HGHT-V/4/8-1250-6/-20/5	1250	20	5	38,6	14,1	505
HGHT-V/4/8-1250-6/-28/6,5	1250	28	6,5	52	18	563
HGHT-V/4/8-1250-6/-30/8	1250	30	8	56,5	21,8	593
HGHT-V/4/8-1250-6/-37/9,2	1250	37	9,2	74,2	25,4	696
HGHT-V/4/8-1250-9/-14/3,5	1250	14	3,5	26,5	8,45	469
HGHT-V/4/8-1250-9/-17/4,3	1250	17	4,3	33,4	12,7	500
HGHT-V/4/8-1250-9/-20/5	1250	20	5	38,6	14,1	515
HGHT-V/4/8-1250-9/-28/6,5	1250	28	6,5	52	18	573
HGHT-V/4/8-1250-9/-30/8	1250	30	8	56,5	21,8	603
HGHT-V/4/8-1250-9/-37/9,2	1250	37	9,2	74,2	25,4	706

### TECHNICAL CHARACTERISTICS - F300 120 - 4/6 POLES

Model	Diameter (mm)	Motor power		Full load current 400V (A)		Weight (kg)
		HS	LS	HS	LS	
HGHT-V/4/6-800-6/-1,5/0,37	800	1,5	0,37	3,65	1,62	167
HGHT-V/4/6-800-6/-2,2/0,7	800	2,2	0,7	4,91	2,48	174
HGHT-V/4/6-800-6/-3/1	800	3	1	6,85	3,86	183
HGHT-V/4/6-800-6/-4,5/1,5	800	4,5	1,5	10,2	5,38	215
HGHT-V/4/6-800-6/-6/2,2	800	6	2,2	13,7	6,96	226
HGHT-V/4/6-800-9/-2,2/0,7	800	2,2	0,7	4,91	2,48	179
HGHT-V/4/6-800-9/-3/1	800	3	1	6,85	3,86	188
HGHT-V/4/6-800-9/-4,5/1,5	800	4,5	1,5	10,2	5,38	220
HGHT-V/4/6-800-9/-6/2,2	800	6	2,2	13,7	6,96	231

Model	Diameter (mm)	Motor power		Full load current 400V (A)		Weight (kg)
		HS	LS	HS	LS	
HGHT-V/4/6-900-6/-2,2/0,7	900	2,2	0,7	4,91	2,48	216
HGHT-V/4/6-900-6/-3/1	900	3	1	6,85	3,86	225
HGHT-V/4/6-900-6/-4,5/1,5	900	4,5	1,5	10,2	5,38	257
HGHT-V/4/6-900-6/-6/2,2	900	6	2,2	13,7	6,96	268
HGHT-V/4/6-900-6/-10/3,3	900	10	3,3	22	8,74	309
HGHT-V/4/6-900-6/-14/4,5	900	14	4,5	29,5	11,2	324

## TECHNICAL CHARACTERISTICS - F300 120 - 4/6 POLES (CONTINUATION)

Model	Diameter (mm)	Motor power		Full load current 400V (A)		Weight (kg)
		HS	LS	HS	LS	
HGHT-V/4/6-900-9/-4,5/1,5	900	4,5	1,5	10,2	5,38	263
HGHT-V/4/6-900-9/-6/2,2	900	6	2,2	13,7	6,96	274
HGHT-V/4/6-900-9/-10/3,3	900	10	3,3	22	8,74	315
HGHT-V/4/6-900-9/-14/4,5	900	14	4,5	29,5	11,2	330
HGHT-V/4/6-1000-6/-4,5/1,5	1000	4,5	1,5	10,2	5,38	272
HGHT-V/4/6-1000-6/-6/2,2	1000	6	2,2	13,7	6,96	283
HGHT-V/4/6-1000-6/-10/3,3	1000	10	3,3	22	8,74	324
HGHT-V/4/6-1000-6/-14/4,5	1000	14	4,5	29,5	11,2	339
HGHT-V/4/6-1000-6/-16/6,5	1000	16	6,5	28,4	12,5	399
HGHT-V/4/6-1000-6/-20/8,5	1000	20	8,5	34,9	16,3	434
HGHT-V/4/6-1000-9/-6/2,2	1000	6	2,2	13,7	6,96	290
HGHT-V/4/6-1000-9/-10/3,3	1000	10	3,3	22	8,74	331
HGHT-V/4/6-1000-9/-14/4,5	1000	14	4,5	29,5	11,2	346
HGHT-V/4/6-1000-9/-16/6,5	1000	16	6,5	28,4	12,5	406
HGHT-V/4/6-1000-9/-20/8,5	1000	20	8,5	34,9	16,3	441

Model	Diameter (mm)	Motor power		Full load current 400V (A)		Weight (kg)
		HS	LS	HS	LS	
HGHT-V/4/6-1250-6/-10/3,3	1250	10	3,3	22	8,74	448
HGHT-V/4/6-1250-6/-14/4,5	1250	14	4,5	29,5	11,2	463
HGHT-V/4/6-1250-6/-16/6,5	1250	16	6,5	28,4	12,5	523
HGHT-V/4/6-1250-6/-20/8,5	1250	20	8,5	34,9	16,3	558
HGHT-V/4/6-1250-6/-26/9	1250	26	9	47,7	18,6	608
HGHT-V/4/6-1250-6/-34/12	1250	34	12	65,6	28	707
HGHT-V/4/6-1250-9/-14/4,5	1250	14	4,5	29,5	11,2	473
HGHT-V/4/6-1250-9/-16/6,5	1250	16	6,5	28,4	12,5	533
HGHT-V/4/6-1250-9/-20/8,5	1250	20	8,5	34,9	16,3	568
HGHT-V/4/6-1250-9/-26/9	1250	26	9	47,7	18,6	618
HGHT-V/4/6-1250-9/-34/12	1250	34	12	65,6	28	717

## DIMENSIONS (mm)

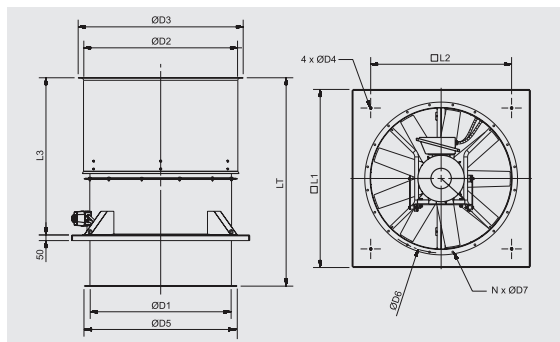

HGHT-V	D1	D2	D3	D4	D5	D6	D7	N	L1	L2	L3	LT
800	800	912	1012	14	890	860	12	16	1100	840	1015	1198
900	900	1013	1113	14	1005	970	15	16	1250	950	1135	1463
1000	1000	1113	1213	14	1105	1070	15	16	1270	950	1215	1543
1250	1250	1364	1464	16	1355	1320	15	20	1580	1250	1394	1848

## MOUNTING ACCESSORIES

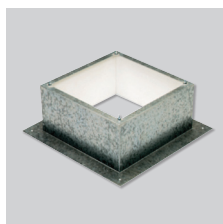

### JBS -V

#### Flat roof up stand

- For mounting a fan on a flat roof without up stands.
- For use on horizontal roofs.
- Internal insulation to prevent condensation.
- Supplied with screws and gasket for a complete weather seal.

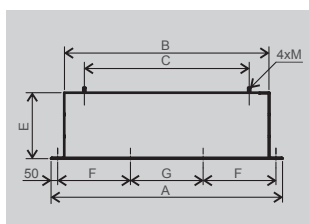

	A	B	C	E	F	G	M
JBS-V-800	1279	1079	840	300	393	393	M12
JBS-V-900	1430	1230	950	400	443	444	M12
JBS-V-1000	1447	1247	950	400	449	449	M12
JBS-V-1250	1755	1555	1250	500	552	551	M16

Model	Matching Flange	Inlet bellmouth	Flexible connector	Inlet guard	Circular sound attenuator	Attenuator with acoustic pod
800	ARO BRIDA TGT/ THGT- 800 N	EMB- 800T	ACOPEL F400-800/300 N	DEF.ASP.TGT/THGT- 800	SIL CZ 800	SIL CZO 800
900	ARO BRIDA TGT/ THGT- 900 N	EMB- 900T	ACOPEL F400-900/300 N	DEF.ASP.TGT/THGT- 900	SIL CZ 900	SIL CZO 900
1000	ARO BRIDA TGT/ THGT- 1000 N	EMB- 1000T	ACOPEL F400-1000/300 N	DEF.ASP.TGT/THGT- 1000	SIL CZ 1000	SIL CZO 1000
1250	ARO BRIDA TGT/ THGT- 1250 N	EMB- 1250T	ACOPEL F400-1250/300 N	DEF.ASP.TGT/THGT- 1250	SIL CZ 1250	SIL CZO 1250

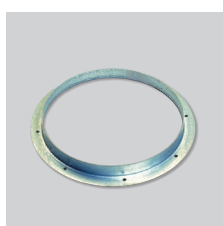

### ARO BRIDA TGT/THGT N

Matching flange.

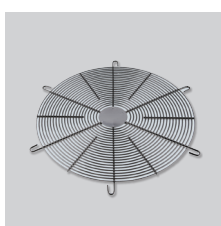

### DEF.ASP.TGT/THGT

Inlet guard.

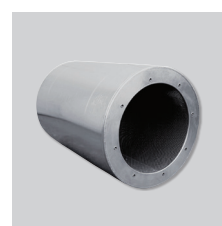

### SIL CZ

Circular silencer.



### ACOPEL F400 N

Circular flexible connector. Certified F400-120.



### EMB

Bellmouth with guard.

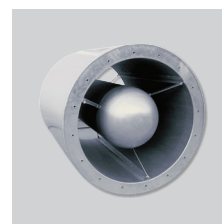

### SIL CZO

Circular silencer with pod.

For more information see Mounting accessories.