



Range of single inlet direct drive centrifugal fans manufactured from tough polypropylene plastic and designed for extraction of corrosive fumes. Provided with forward curved centrifugal impellers manufactured from polypropylene plastic. Available, depending upon the model, with single or three phase motors in 2 or 4 poles. Working temperature from -10°C to +60°C.

Motors

All motors are IP55, class F.
 Electrical supply:
 Single phase 230V-50Hz, on request.
 Three phase 230/400V-50Hz.
 Three-phase motor speed controllable by inverter.
 (See characteristics chart).

Additional information

The scroll can be orientated.
 Standard supplied position: LG 0.

On request

PVC versions for 160 to 355 sizes.

ATEX versions

ATEX versions available for 3-phase models.
 For ambient working temperature -10°C to +40°C.
 Motor IP55, Class F.
 - ATEX Flameproof - Gas
 Ⓜ II 2G Exd IIB T4
 Ⓜ II 2G Exd IIB+H2 T4 (with motor Exd IIC T4)
 - ATEX Increased safety - Gas
 Ⓜ II 2G Exe II T3

To select CMPT (1) ATEX refer to performance data, or Easyvent.
 Note electrical data may vary for ATEX motors.



Tough, durable design
 Scroll made of high grade polypropylene providing a high robustness.



Impeller dynamically balanced
 Forward curved centrifugal impellers manufactured from polypropylene plastic and dynamically balanced, according to ISO 1940 standard.

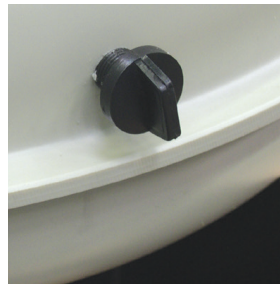

Condensation drain hole
 Draining hole allowing the evacuation of condensation. Provided with a threaded cap.

Specific applications



Corrosive atmospheres



Versions

GENERAL APPLICATIONS USING POLYPROPYLENE CMPT FANS INCLUDE:					
Sulphuric acid	Sulphurous acid	Nitric acid	Nitrous acid	Hydrofluoric Acid	Boris acid
Hydrocyanic acid	Hydrochloric acid	Ammonia	Soda	Ethanol	Potassium hydroxide
Methanol	Propane	Formol	Benzene	Formaldehyde	

Special versions made of PVC for the extraction of fumes containing chromium and derivates available under request.
 For other products, please contact us.

POSITIONS

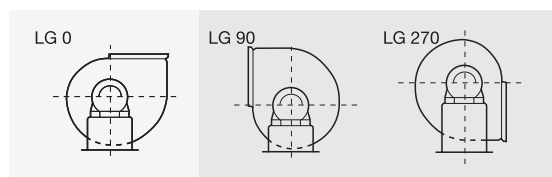

Standard position: LG0.

TECHNICAL CHARACTERISTICS

Before installation check that the product electrical characteristics listed on the data plate label (voltage, power, frequency, etc.) match those of the intended electrical supply.

Model	Speed (rpm)	Motor power (kW)	Maximum absorbed current (A)		Maximum airflow (m³/h)	Sound pressure level* (dB(A))	Weight (kg)
			230 V	400 V			
SINGLE PHASE 2 POLE							
CMPB/2-140	2700	0,09	1,15	–	615	60	6,2
CMPB/2-160	2850	0,37	2,87	–	1.150	69	11,3
CMPB/2-200	2820	1,5	10	–	3.100	81	16,6
SINGLE PHASE 4 POLE							
CMPB/4-160	1370	0,25	2,3	–	830	54	11,3
CMPB/4-200	1350	0,37	3,06	–	1.850	66	18,1
CMPB/4-250	1350	1,5	9,9	–	3.650	69	28,9
THREE PHASE 2 POLE							
CMPT/2-140	2750	0,09	0,7	0,4	615	60	6,4
CMPT/2-160	2820	0,37	1,9	1,1	1.150	69	10,8
CMPT/2-200	2870	1,5	6,1	3,5	3.100	81	17,6
THREE PHASE 4 POLE							
CMPT/4-160	1360	0,25	1,04	0,6	830	54	10,8
CMPT/4-200	1370	0,37	1,82	1,05	1.850	66	17,6
CMPT/4-250	1420	1,5	–	3,5	3.650	69	35,2
CMPT/4-315	1430	2,2	–	4,9	5.800	77	59,8
CMPT/4-355	1460	4	–	8,6	8.300	86	74,5

* Measured at 1,5 m in free field.

DIMENSIONS (mm)

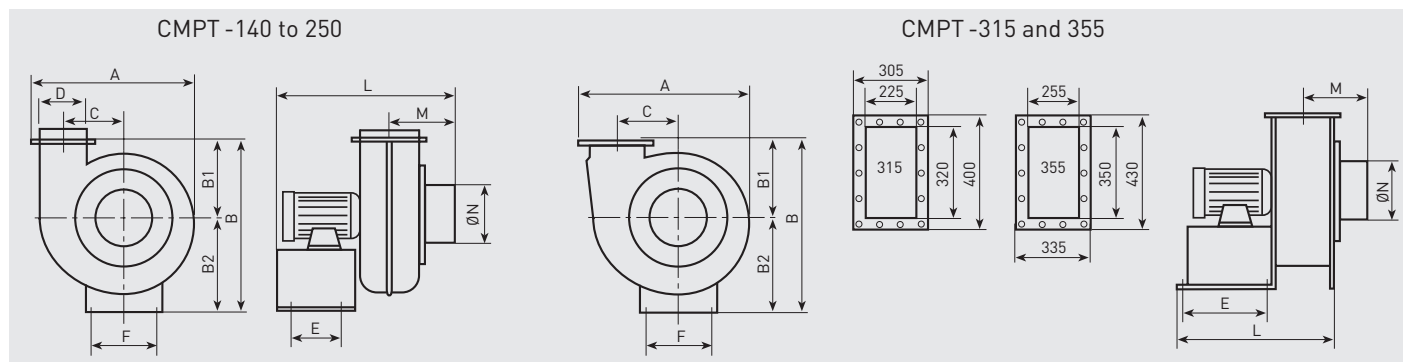

Model	A	B	B1	B2	C	E	F	L	M	ØN	ØD
140	410	480	180	250	130	125	210	350	100	140	140
160	445	525	200	260	150	125	210	440	130	160	160
200	590	700	275	360	240	160	295	480	182	200	200
250	790	905	375	465	290	200	486	620	215	250	250
315	913	840	380	460	340	305	390	598	220	315	–
355	990	907	395	512	375	320	380	621	260	355	–

PERFORMANCE CURVES

- q_v : Airflow in m^3/h and m^3/s .
- p_{sf} : Static pressure in mmWG and Pa.
- Dry air at 20°C and 760 mmHg.
- Performance data in accordance with ISO 5801 and AMCA 210-99 Standards.
- Input power in W
- Sound pressure level measured in dB(A), at 1,5m from the fan inlet, in free field condition.

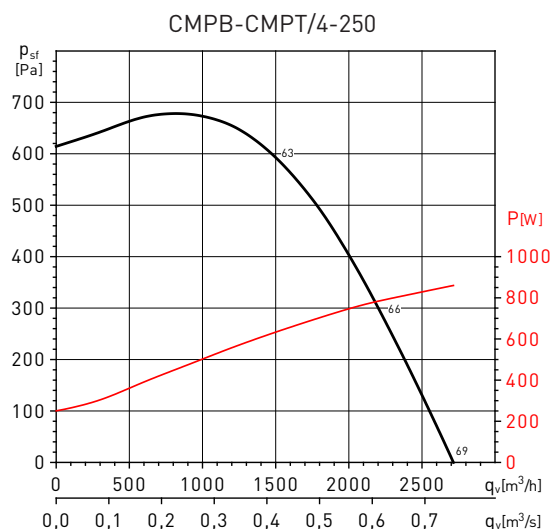
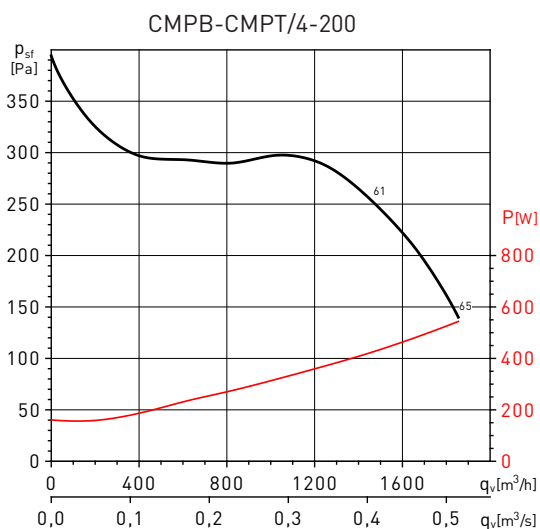
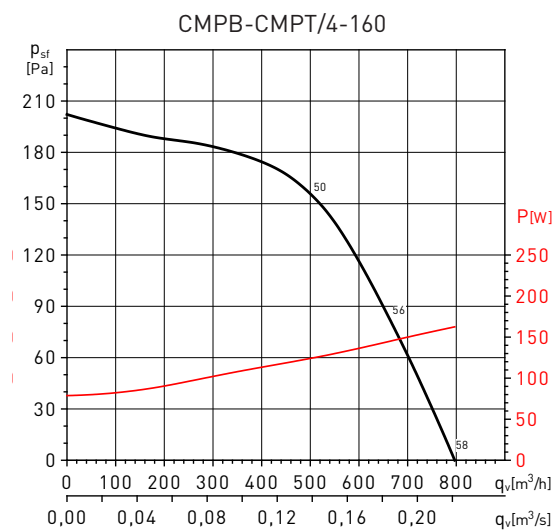
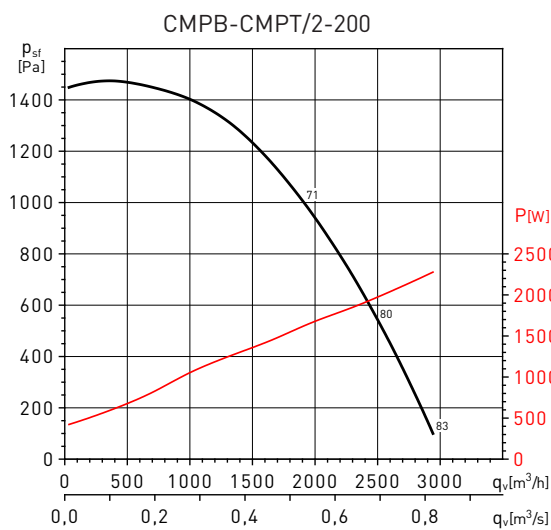
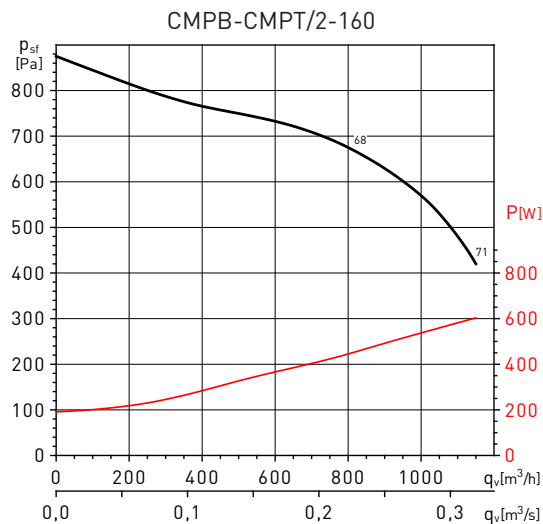
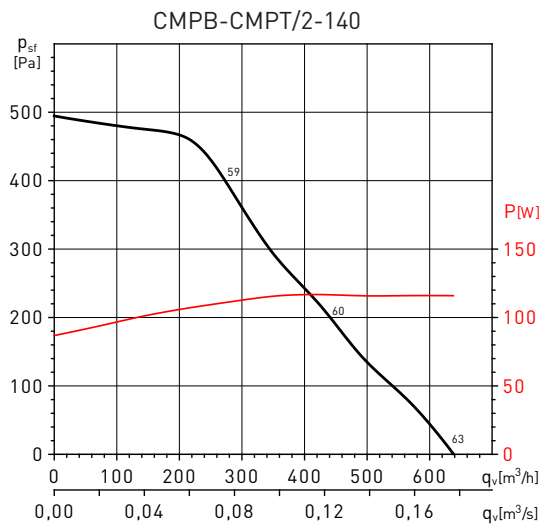

PERFORMANCE CURVES

- q_v : Airflow in m^3/h and m^3/s .
- p_{st} : Static pressure in mmWG and Pa.
- Dry air at 20°C and 760 mmHg.
- Performance data in accordance with ISO 5801 and AMCA 210-99 Standards.
- Input power in W
- Sound pressure level measured in dB(A), at 1,5m from the fan inlet, in free field condition.

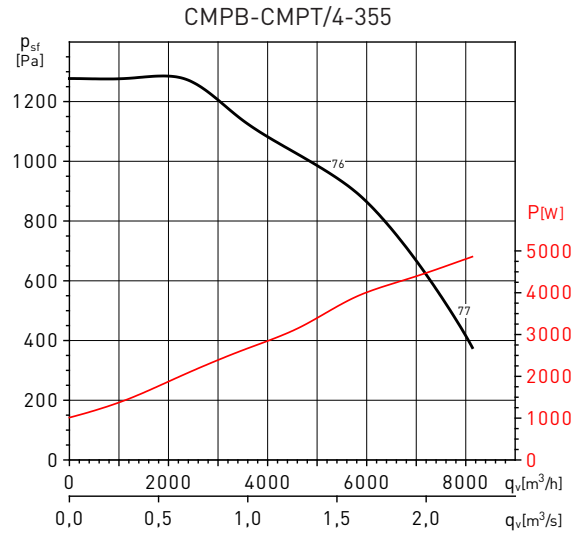
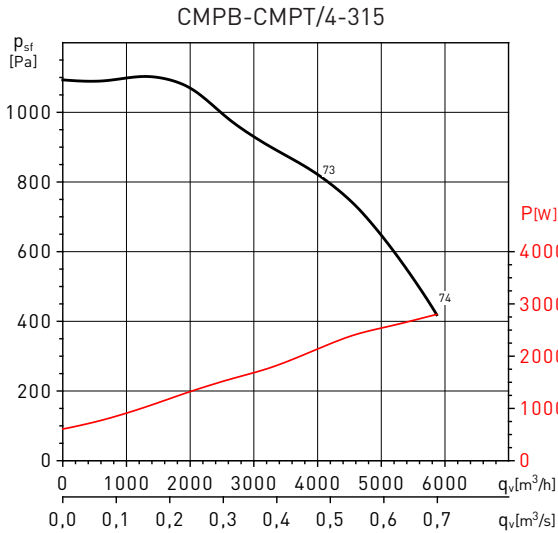

ACOUSTIC CHARACTERISTICS

Sound power spectrums, at the fan inlet and outlet, at three points of the performance curve; low pressure (L), medium pressure (M) and high pressure (H).

CMPT/2-140			63	125	250	500	1000	2000	4000	8000	LwA
INLET	B	46	52	57	71	74	69	67	55	77	
	M	46	50	56	70	72	66	61	51	75	
	H	44	53	59	66	72	62	58	50	74	
OUTLET	B	31	48	61	71	73	71	69	56	77	
	M	32	48	61	70	69	66	63	48	74	
	H	35	51	63	66	66	61	57	48	71	

CMPT/2-160			63	125	250	500	1000	2000	4000	8000	LwA
INLET	M	53	59	68	77	84	77	72	66	86	
	H	52	60	69	75	81	74	69	63	83	
	M	50	59	73	78	81	78	74	65	85	
OUTLET	H	52	60	72	75	77	75	70	63	82	

CMPT/2-200			63	125	250	500	1000	2000	4000	8000	LwA
INLET	B	57	69	76	85	97	89	83	80	98	
	M	59	67	77	84	93	87	81	78	95	
	H	60	66	78	83	88	84	79	75	91	
OUTLET	B	78	85	91	91	94	91	85	81	99	
	M	65	68	83	85	91	89	83	79	94	
	H	66	67	79	82	87	86	81	75	91	

CMPT/4-160			63	125	250	500	1000	2000	4000	8000	LwA
INLET	B	35	45	54	63	69	66	62	56	72	
	M	31	44	55	62	67	63	59	53	70	
	H	27	39	51	58	62	57	53	48	65	
OUTLET	B	41	51	66	66	66	64	64	57	72	
	M	36	45	63	59	64	63	62	54	70	
	H	31	41	55	58	61	60	60	49	66	

CMPT/4-200			63	125	250	500	1000	2000	4000	8000	LwA
INLET	M	45	55	66	72	76	70	65	59	79	
	H	49	55	63	68	73	67	62	55	76	
	M	54	63	74	72	75	72	67	60	80	
OUTLET	H	49	56	66	69	72	69	63	55	76	

CMPT/4-250			63	125	250	500	1000	2000	4000	8000	LwA
INLET	B	51	60	70	77	81	75	70	64	84	
	M	48	58	68	74	78	72	67	61	81	
	H	53	59	66	70	75	69	63	56	78	
OUTLET	B	66	74	81	81	81	77	72	65	87	
	M	58	66	76	74	78	74	68	61	82	
	H	53	60	68	71	74	70	64	56	78	

CMPT/4-315			63	125	250	500	1000	2000	4000	8000	LwA
INLET	M	61	68	78	83	85	78	72	66	89	
	H	72	74	77	80	85	78	71	63	88	
OUTLET	M	75	82	87	86	88	82	73	66	93	
	H	70	74	79	80	83	78	67	61	87	

CMPT/4-355			63	125	250	500	1000	2000	4000	8000	LwA
INLET	M	66	72	82	87	88	80	74	68	92	
	H	78	78	80	83	88	81	73	65	91	
OUTLET	M	80	87	90	90	91	85	74	68	96	
	H	75	78	82	84	87	81	69	63	90	

ACCESSORIES



CARP
Manually operated
circular damper.



CTP
Exhaust cowl.



MFP
Circular flexible
connector.



APP
Round outlet
protection.

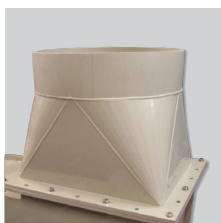

ACP
Circular connector.

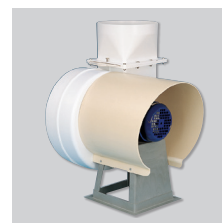

CMP
Motor shield.



CPTA-S/CPTA-E
Presence detector.