



Whole house heat recovery unit with a high-efficiency heat exchanger up to 92% setting and very low consumption EC motor.

Provides a constant supply of fresh tempered air into the living spaces of a home.

It also enables management of a pre-heating or post heating battery.

To optimise energy consumption at the same time as air quality, a proportional sensor can be connected (CO₂, Humidity...).

Domeo 210 is fitted with a 100% by-pass and to ensure very good air quality, it is equipped with a F5 filters at the inlet and at the outlet to protect the heat exchanger.

Thanks to its control, it is possible to adjust the boost, the by-pass and reset the filter change from the kitchen.

Features

- Counter-flow heat exchanger with up to 92% thermal efficiency
- EC motor
- Centrifugal backward curved impeller
- EPP body
- Nozzles Ø125 mm
- Remote control by cable
- By-pass 100% automatic or manual
- Manual boost mode
- F5 filters



ectechnology



Very compact.



Controller.

Specific applications



Multi dwelling blocks



Heat recovery unit

EASY MAINTENANCE



Easy access to filters.

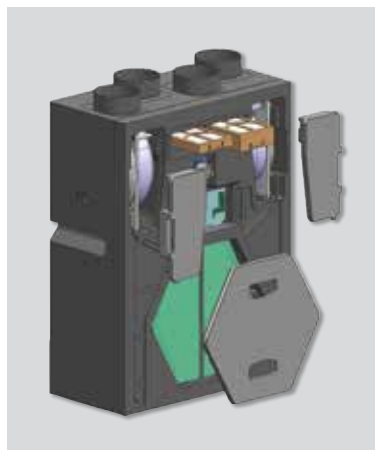
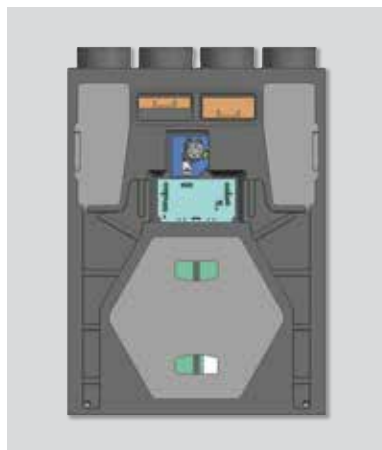

Easy to access: fans, heat exchanger and by-pass.

TECHNICAL CHARACTERISTICS

Model	Efficiency %	Voltage (V)	Maximum airflow (m ³ /h)	Absorbed power (W)
DOME0 210	92	230	210	100

DIMENSIONS (mm)

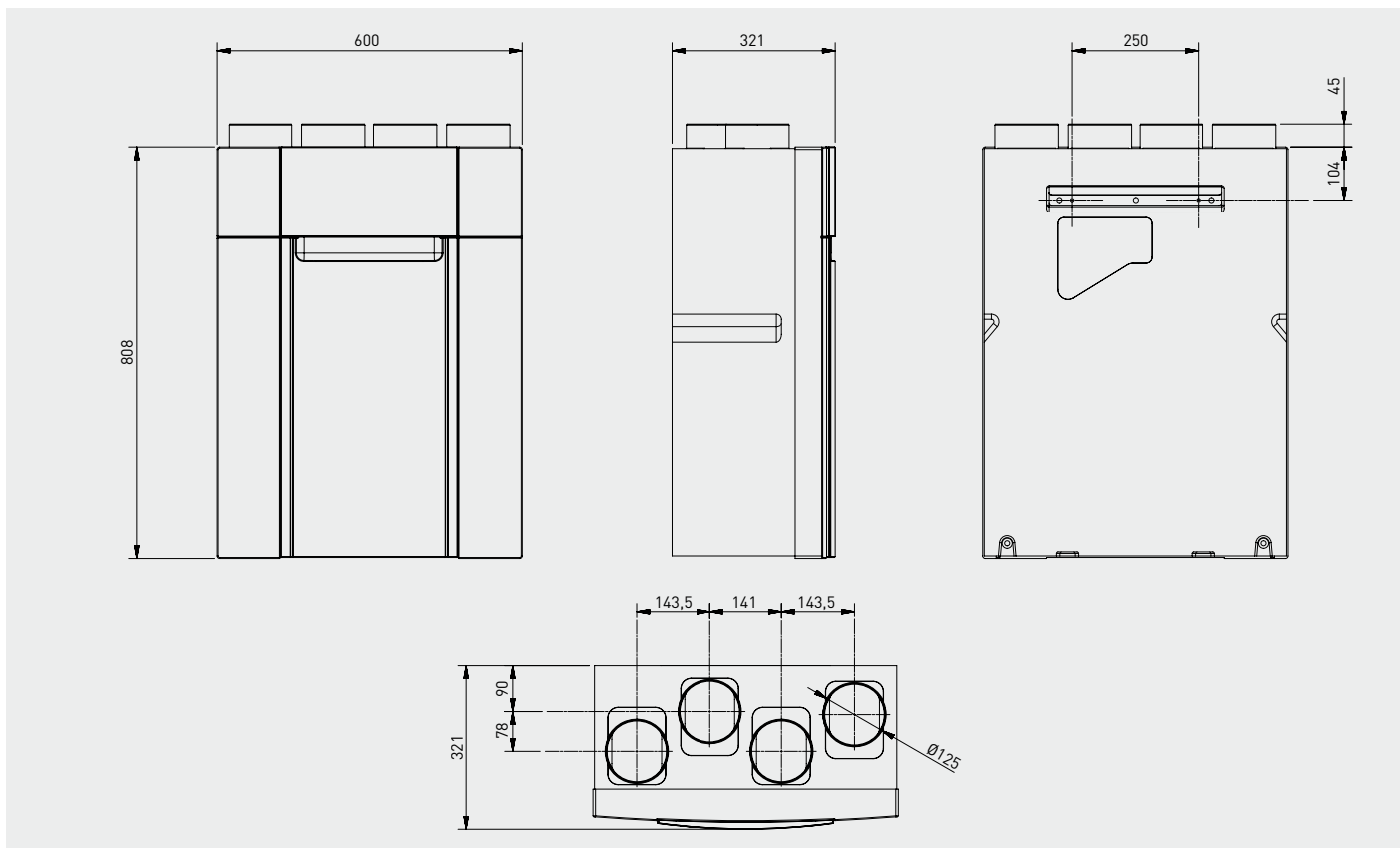

MOUNTING ACCESSORIES



BAR
Self-adjusting calibrated outlets.



BDOP
Inlets and outlets.

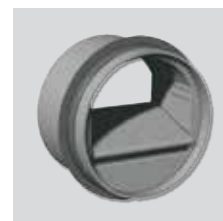

RD
Airflow calibrated regulator for BDOP.

EXAMPLE OF TEMPERATURE RECOVERY IN WINTER

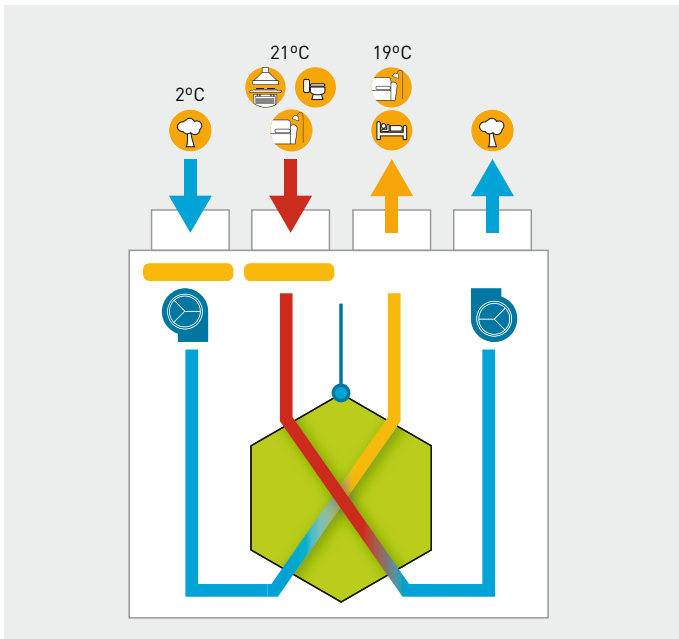

Operation without by-pass

- Air inside home: 21°C.
 - Outdoor air: 2°C.
 - New air heated and blown inside the home: 19°C.
- With a simple flow system, the new air would enter at 2°C through the air inlets, which would lower the interior temperature of the home.
 With the balanced flow system, the new air would enter at 19°C.

EXAMPLE OF RECOVERY OF TEMPERATURES IN SUMMER DURING THE DAYTIME

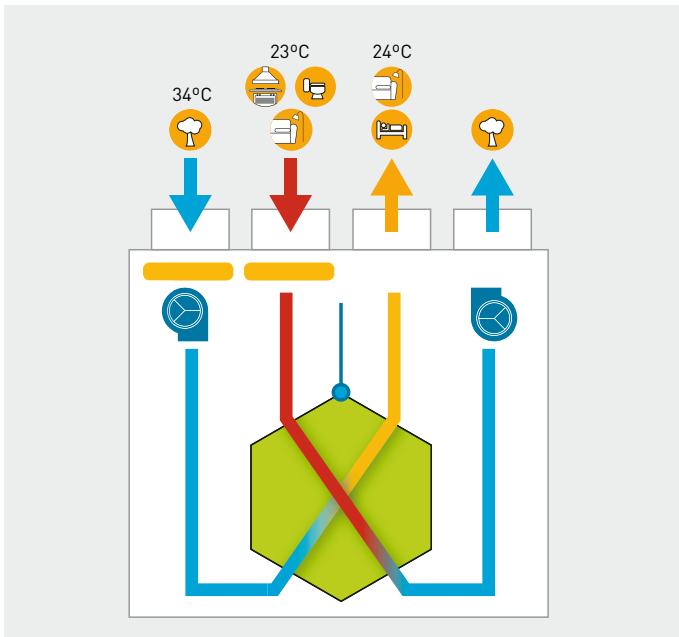

Operation with by-pass

- Air inside home: 23°C.
 - Outdoor air: 34°C.
 - New air heated and blown inside the home: 24°C.
- With a simple flow system, the new air would enter at 34°C through the air inlets, which would rise the interior temperature of the home.
 With the balanced flow system, the new air would enter at 24°C and prevents the rise of the interior temperature.

EXAMPLE OF RECOVERY OF TEMPERATURES IN SUMMER DURING THE NIGHT (FREE COOLING)

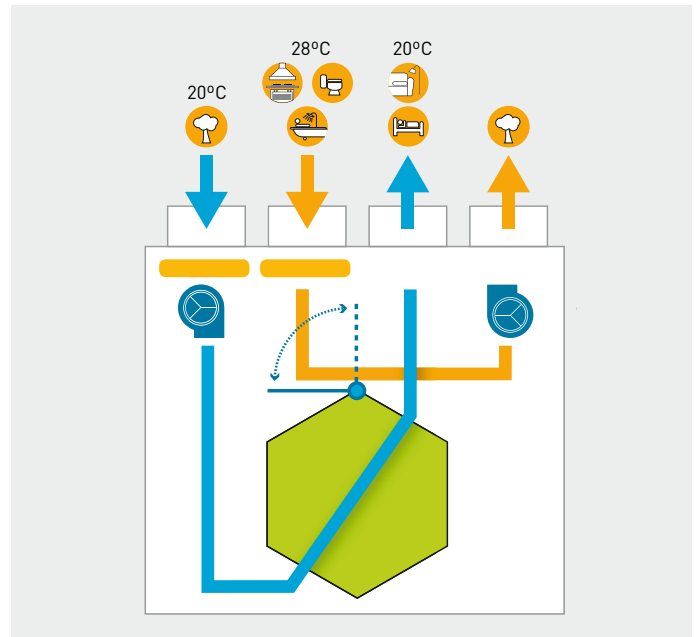

Operation with by-pass

- Air inside home: 28°C.
 - Outdoor air: 20°C.
 - New air heated and blown inside the home: 20°C.
- In addition, during the summer nights, when the outdoor air is colder than the indoor air, the air does not pass through the exchanger, the by-pass is activated automatically and air goes directly into the home.

Heat recovery	Fan	By-pass	Filter	Kitchen	Rooms	Lounge	W.C.	Bath	Outside the home