



VENT-100 to VENT-315



VENT-355 and VENT-400

Range of in-line duct centrifugal fans, manufactured from high grade corrosion resistant pressed galvanised steel and supplied as standard with a pre-wired wiring junction box and a robust mounting foot. All model include an enclosed type, single-phase external rotor motor with factory matched backward curved nonstalling impeller. (1) Models 355 and 400 are manufactured in sheet steel protected against corrosion by cataforesis primer and black polyester paint finish.

Motors

100 – 315 models: Motors are IP44, class B insulation with ball bearings and safety thermal overload protection.

355 and 400 models: Motors are IP54, class F, with ball bearings and safety thermal overload protection.

Electrical supply:

Single phase 230V-50/60Hz.

Three phase 230/400V-50Hz (models 355 and 400). (See characteristics chart).

All models are speed controllable.

Additional Information

"L" version: High performance models.

"B" Version: Standard performance models for lower noise level requirements.

Impellers from 100 to 160 models are manufactured from injection moulded plastic.



Mounting foot

Supplied with unit as standard (100-315 models).

TECHNICAL CHARACTERISTICS

Before installation check that the product electrical characteristics listed on the data plate label (voltage, power, frequency, etc.) match those of the intended electrical supply.

Model	Voltage (V-Hz)	Speed (rpm)	Maximum absorbed power (W)	Maximum absorbed current (A)	Maximum airflow (m ³ /h)	Sound pressure level at 3m (dB(A))	Minimum ambient temperature (°C)	Maximum ambient temperature (°C)	Weight (kg)	Electric scheme*
VENT-100B	230V-50/60Hz	2100	48	0,22	235	38	-40	40	3	19
VENT-100L	230V-50/60Hz	2500	75	0,33	290	47	-40	60	3	19
VENT-125B	230V-50/60Hz	1900	44	0,21	280	39	-40	40	3	19
VENT-125L	230V-50/60Hz	2450	80	0,35	410	47	-40	60	3	19
VENT-150B	230V-50/60Hz	2100	70	0,30	560	46	-40	60	5	19
VENT-150L	230V-50/60Hz	2700	120	0,53	700	50	-40	60	5	19
VENT-160B	230V-50/60Hz	2200	70	0,30	600	45	-40	60	5	19
VENT-160L	230V-50/60Hz	2750	130	0,55	760	51	-40	60	5	19
VENT-200B	230V-50/60Hz	2250	125	0,50	830	47	-40	60	5	19
VENT-200L	230V-50/60Hz	2600	170	0,72	1000	52	-40	60	5	19
VENT-250B	230V-50/60Hz	2300	130	0,55	935	49	-40	60	6	19
VENT-250L	230V-50/60Hz	2750	180	0,80	1100	54	-40	60	6	19
VENT-315B	230V-50/60Hz	2400	230	1,00	1475	49	-40	50	8	19
VENT-315L	230V-50/60Hz	2700	315	1,30	1630	57	-40	50	8	19
VENT-355L	230V-50/60Hz	1350	280	1,20	2650	60	-40	70	17	19
VENT-400L	230V-50/60Hz	1250	400	1,60	3380	61	-40	50	22	20
VENT-355L-T	230/400V-50Hz	1375	290	1,4/0,8	2650	60	-40	70	17	21
VENT-400L-T	230/400V-50Hz	1360	450	1,9/1,1	3380	61	-40	50	22	21

* See section Electric Schemes.

DIMENSIONS (mm)

Mounting with the motor in horizontal position.

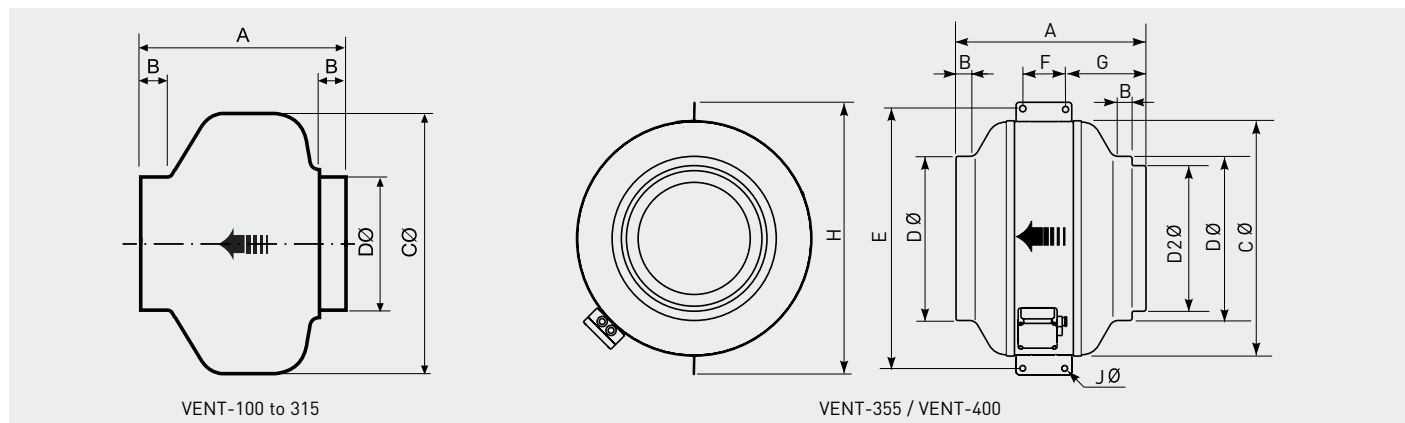

Model	A	B	C	D	D2	E	F	G	H	J
VENT-100	194	23	243	98						
VENT-125	195	27	243	123						
VENT-150	214	24	333	147						
VENT-160	222	28	333	157						
VENT-200	223	25	333	198						
VENT-250	206	27	333	248						
VENT-315	230	25	401	312						
VENT-355	410	25	508	354	314	552	100	170	587	10,5
VENT-400	431	25	568	399	354	628	100	185	647	10,5

ACOUSTIC CHARACTERISTICS

Sound power level spectrums (LwA) at the maximum airflow (0Pa).

Model	LwA	63	125	250	500	1000	2000	4000	8000	TOT
100L	Inlet	44	53	63	60	67	61	52	41	70
	Outlet	42	48	67	61	63	61	55	44	70
	Radiated	42	44	53	51	46	45	40	33	56
100B	Inlet	37	43	54	49	59	54	48	39	61
	Outlet	38	42	56	48	53	53	49	38	60
	Radiated	36	33	32	36	40	38	34	26	45
125L	Inlet	38	47	59	67	65	62	56	44	70
	Outlet	38	45	61	64	63	63	56	46	69
	Radiated	37	43	45	51	47	45	42	33	54
125B	Inlet	33	43	55	57	57	55	51	41	62
	Outlet	34	41	57	53	55	56	52	41	62
	Radiated	34	36	35	38	41	39	37	28	46
150L	Inlet	40	45	63	73	69	64	61	46	75
	Outlet	40	45	63	66	67	64	61	47	72
	Radiated	40	37	46	59	51	50	43	30	60
150B	Inlet	36	44	58	70	64	60	56	40	71
	Outlet	36	43	55	62	62	59	56	40	67
	Radiated	36	38	40	53	46	45	41	29	55
160L	Inlet	39	45	63	74	70	67	63	48	77
	Outlet	43	45	61	67	68	65	62	49	72
	Radiated	43	36	44	60	52	51	45	32	61
160B	Inlet	35	41	56	69	63	60	56	42	71
	Outlet	35	42	54	63	61	59	57	42	67
	Radiated	35	37	37	52	45	45	42	29	54

Model	LwA	63	125	250	500	1000	2000	4000	8000	TOT
200L	Inlet	42	52	63	70	69	68	66	60	75
	Outlet	43	51	63	70	69	69	68	59	75
	Radiated	43	48	40	51	53	52	49	39	58
200B	Inlet	41	53	60	67	66	64	63	52	72
	Outlet	42	51	61	65	66	66	65	53	72
	Radiated	42	42	34	46	48	53	46	37	56
250L	Inlet	43	57	67	71	72	70	70	60	78
	Outlet	42	53	67	73	75	75	72	62	80
	Radiated	36	52	37	53	53	51	50	38	59
250B	Inlet	42	53	62	68	69	66	66	57	74
	Outlet	39	48	62	70	70	69	67	59	76
	Radiated	38	43	36	52	48	50	48	42	56
315L	Inlet	45	58	70	74	75	76	71	66	81
	Outlet	57	58	72	76	77	77	72	68	83
	Radiated	51	54	49	56	61	59	56	48	65
315B	Inlet	44	59	68	70	71	70	67	60	77
	Outlet	44	51	71	72	75	74	69	64	80
	Radiated	43	43	47	50	52	55	53	43	59
355L	Inlet	40	57	68	71	71	67	59	48	76
	Outlet	42	59	62	69	70	68	60	50	74
	Radiated	41	55	43	50	55	51	42	29	59
400L	Inlet	42	61	69	72	67	66	63	50	76
	Outlet	47	63	66	70	69	68	64	51	75
	Radiated	45	58	45	52	52	50	46	30	61

PERFORMANCE CURVES

- q_v : Air volume in m^3/h and m^3/s .
- p_{sf} : Static pressure in mmWG and Pa.
- Dry air at 20°C and 760 mmHg.
- Performance data in accordance with ISO 5801 and AMCA 210-99 Standards.

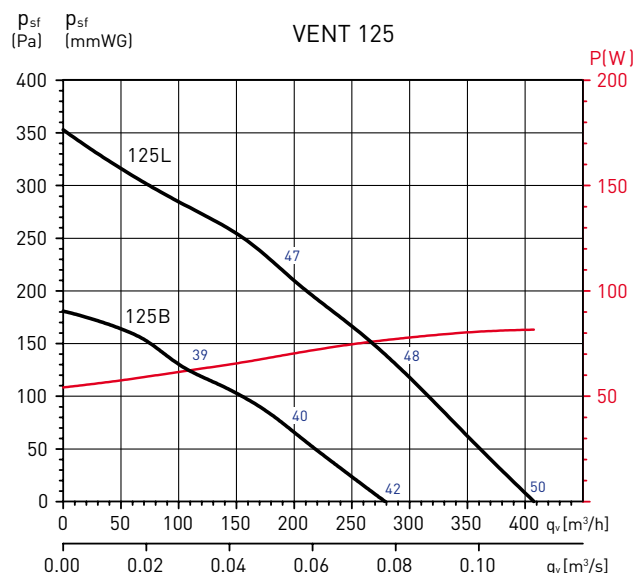
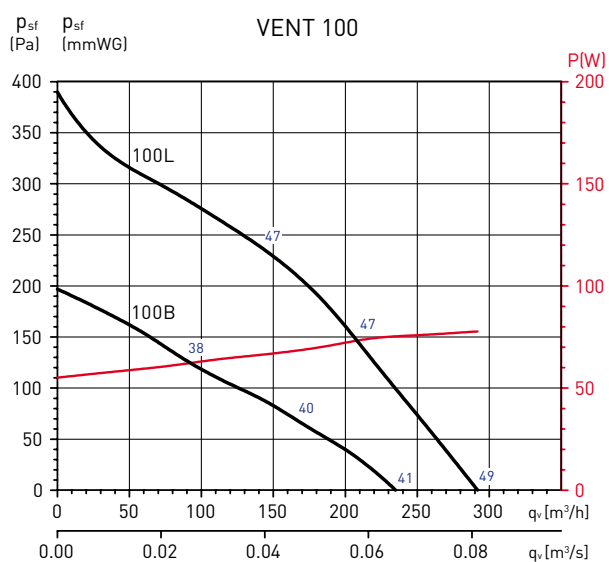

PERFORMANCE CURVES

- q_v : Air volume in m^3/h and m^3/s .
- p_{sf} : Static pressure in Pa.
- Dry air at $20^\circ C$ and 760 mmHg.
- Performance data in accordance with ISO 5801 and AMCA 210-99 Standards.

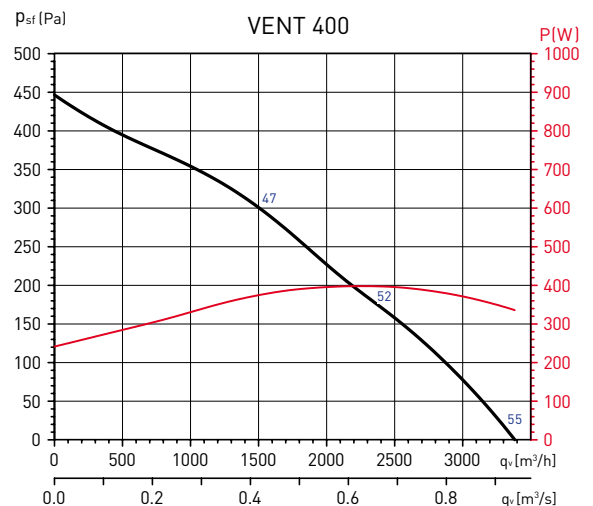
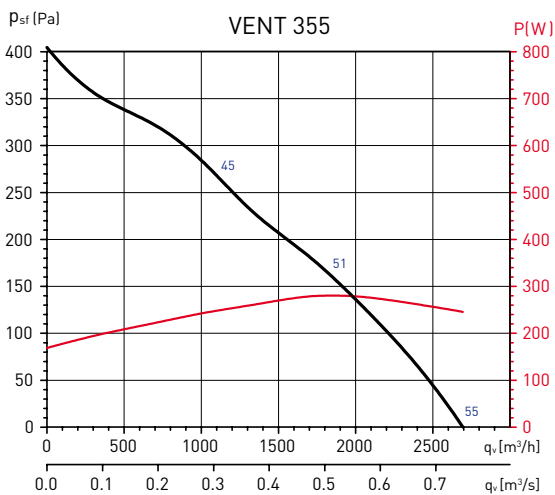
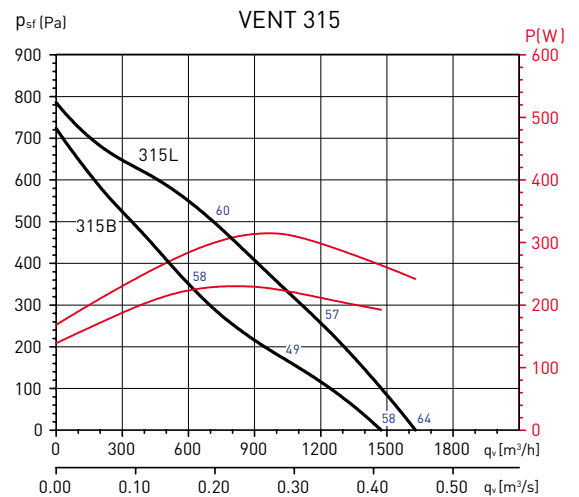
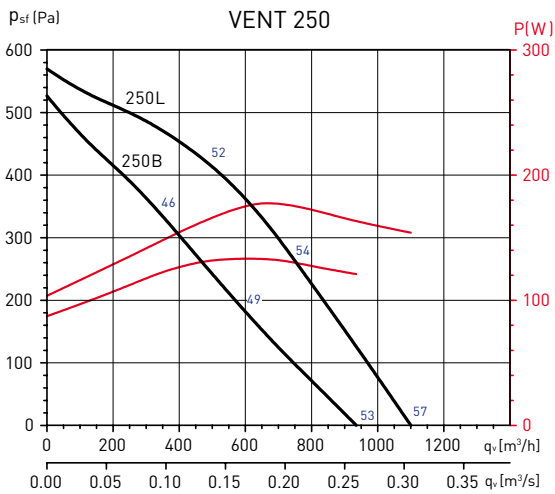
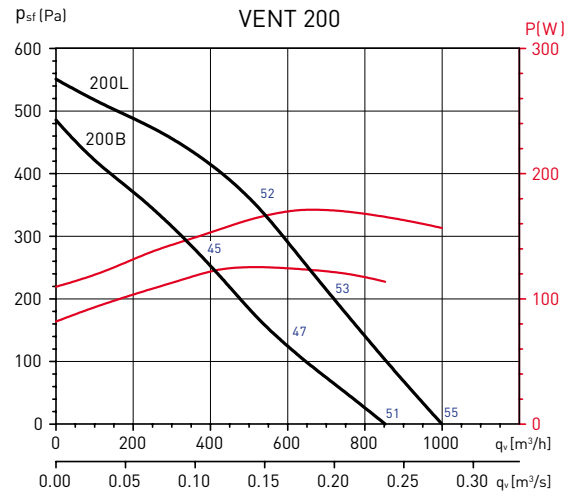
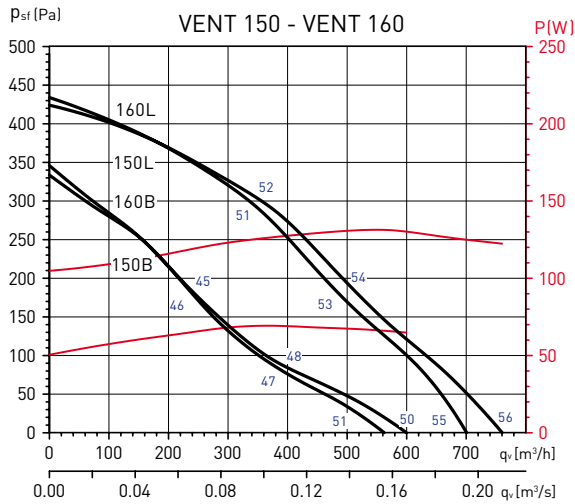

MOUNTING ACCESSORIES



MBE
Electric heater.



MBW
Hot water coil.



SIL
Circular sound attenuators.



MFL-G4
Filtration box of G4 grade filtration.



MFL-F
Box in galvanized steel for inserting the MFR F5, F6 and F7 filters.



Mounting foot
(supplied with unit as standard).



ACOP-VENT
Flexible connectors.



DEF-VENT
Protection grille.



GSA M0
Aluminium flexible ducting.



GSI M0
Insulated aluminium ducting.



CX
Worm drive duct connectors.



BOC
Metal inlet valves.



BOR
Plastic inlet valves.

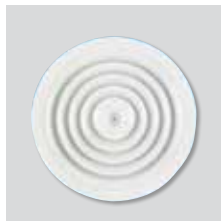

GCI
Circular inlet grilles.



GRI
Interior square grilles.



VR
GCI mounting frame.

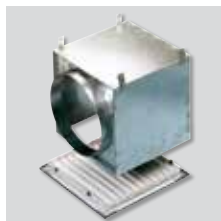

RP
GRI mounting frame.



CAR
Backdraught shutters.

For more information see Mounting accessories.

ELECTRICAL ACCESSORIES



REB
Electronic single phase speed controllers.



RMB
Autotransformer single phase speed controllers.



PARO/MARCHA 5P and 8P
ON/OFF electrical isolation switch.



PULSER
Electric heater controllers for 1Ph models up to 3600W and 3Ph models up to 6400W.



TTC 2000
Electric heater controllers for 3 phase models.



TG-K
Duct temperature sensor.



TG-R
Room wall mounted temperature sensor.

For more information see Electrical accessories.